

Series F

Digital Force Testers

M EasyMESUR®



MARK-10®

Force and Torque Measurement Engineered Better

Force Measurement Simplified

Series F Tension / Compression Test Frames are engineered for force testing applications up to 1,500 lbF (6.7 kN). Select from a broad range of force sensor capacities and an expansive array of grips and fixtures.

Set up tests, view results, and export data via the integrated EasyMESUR® control panel. Satisfy various test methods through an easy-to-use interface, with a menu of available optional functions and function packages. The system can be tailored to your unique needs and budget, and is easily upgradeable in the field.



Virtually limitless applications

From food packaging to electronics, from consumer products to aerospace manufacturing, Mark-10 force test frames are at home in laboratory and production environments in virtually every industry worldwide.



Peel testing



Wire tensile testing



Compression spring testing

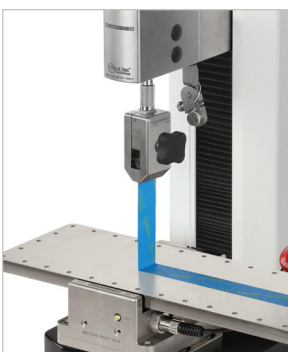

90° peel testing



Score bend testing



Tension spring testing

Table of Contents

Test Frames.....	03
EasyMESUR®.....	05
Serviceability.....	11
In The Box.....	12
Optional Equipment.....	13
Specifications.....	15
Ordering Information.....	20



Engineered For Performance

There's a Series F test frame for every need and budget. Select from a wide range of force capacities, heights, and form factors.



F105 | F305 | F505

F755 | F1505

F755S | F1505S

F505H

	F105	F305	F505	F505H	F755	F755S	F1505	F1505S
Force Capacity:	100 lbF [0.5 kN]	300 lbF [1.3 kN]	500 lbF [2.2 kN]	500 lbF [2.2 kN]	750 lbF [3.4 kN]	750 lbF [3.4 kN]	1,500 lbF [6.7 kN]	1,500 lbF [6.7 kN]
Travel Distance:	18.0 in [457 mm]	18.0 in [457 mm]	18.0 in [457 mm]	18.0 in [457 mm]	32.0 in [813 mm]	14.2 in [360 mm]	32.0 in [813 mm]	14.2 in [360 mm]

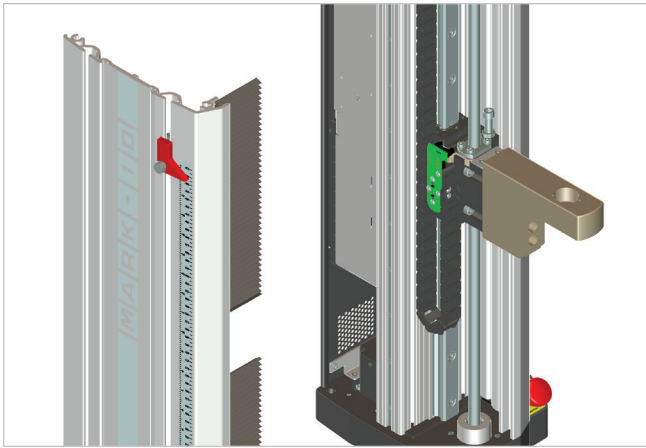

Rigid and precise mechanical design

Exceptionally rigid extrusion-based frames are engineered for stiffness. Factory compensation of test frames and force sensors ensure **position accuracy of ± 0.006 in / 0.15 mm under any load, at any position.**

Stepper motors and controllers drive a ballscrew and linear guideway for smooth, quiet operation, with virtually no speed variation under load.



Seamless force sensor interface

Series FS05 smart force sensors mount directly to the crosshead of models F105, F305, F505, and F505H, without any connecting cables. Ranges available from 0.12 to 500 lbf [0.5 N to 2.5 kN]. Accurate to **$\pm 0.1\%$ of full scale.**

Series FS06 force sensors accommodate larger and heavier grips and fixtures and are compatible with models F105, F305, F505, and F505H. Ranges are available from 50 to 500 lbf [250 N to 2.5 kN]. Accurate to **$\pm 0.15\%$ of full scale.**

Series R07 S-beam type force sensors accommodate higher force ranges, also compatible with Plug & Test® technology. Designed for models F755, F755S, F1505, and F1505S. Ranges available from 50 to 1,500 lbf [250 N to 7.5 kN]. Accurate to **$\pm 0.15\%$ of full scale.**



Modular design

Frame bases can be removed to accommodate column extensions and alternative mounting configurations. Most electronics are housed in a self-contained enclosure, easily accessed and replaced if needed.

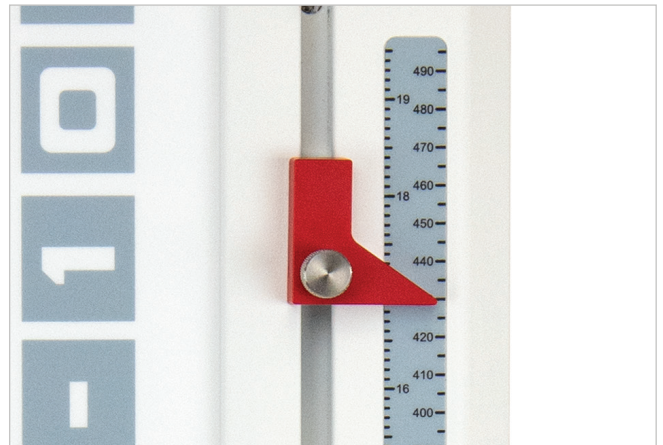

Limit switches

Solid-state upper and lower limit switches may be used as test limits or as test exceptions. Dual-graduated rulers aid in switch placement.



An integrated motion control and data collection solution

M EasyMESUR®

The EasyMESUR® integrated control panel centralizes test setup, test frame control, and data collection into one convenient place. Use the 7" [177 mm] touchscreen to create and run a wide range of tests, including:

- **Test to a load**
- **Test to a sample break**
- **Test to a distance**
- **Load holding**
- **Cycle testing**
- **Average load testing**
- **Coefficient of friction testing**
- **Spring testing**

View data in graphical format or results tables. Save or export data as needed, or generate a report.



Key features

What's your point of view?

Run a test via any of the following views:

Standard view

View load and distance values with clear, simple controls.



Graph view

View a graph of load vs. distance or time, with pass/fail status.



Results view

View results for each run, with corresponding statistics for the results.



Secure user access

Control user access to sensitive areas, such as test editing and calibration via password.

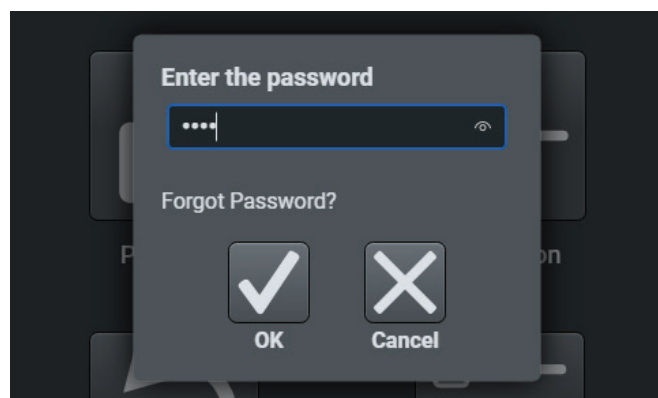

Easy Test Access

Open and edit tests saved within the control panel or external USB drive.

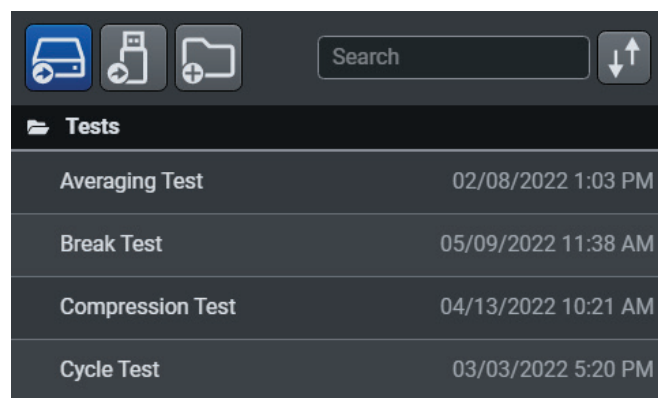

Control panel features



Rugged aluminum housing

7" touch display

USB-C port for connection to a PC

Import and export results, reports, and test files to a PC.

USB-C port for an external flash drive & data output

Import and export results, reports, and test files to a USB flash drive. Or, interface with third-party software via the available UXU100 communication adapter.



Intelligent manual control

Manually control the test frame to obtain quick load and distance results, or position the crosshead prior to a test. Select from several actuation methods, including momentary (button-hold), maintained (button release) motion, jog mode with three incremental distance presets.

With Mark-10's innovative **FollowMe®** function, push and pull on the force sensor to move the crosshead. Apply greater force to achieve faster motion. FollowMe® is responsive enough for quick positioning as well as fine adjustments.



FollowMe®



Manual Control view

Test setup is easy as 1-2-3

Select a test type, and EasyMESUR® will guide you through the setup.



Load Limit



Distance Limit

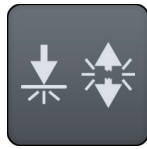

Break Limit



Load Hold

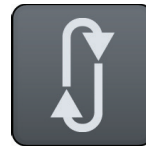

Cycle

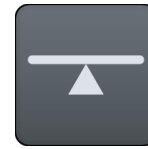

Averaging

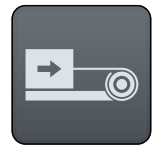

CoF

1. Basic Test Settings

- Test direction
- Speed
- Test-specific parameters
- Data storage preferences

2. Results Settings

- Select results
- Configure pass/fail limits
- Set data collection rate
- Set auto-return to home
- Data collection & graphing start threshold

3. Graph Settings

- Single-point or continuous graphing
- Select load vs. time or vs. distance

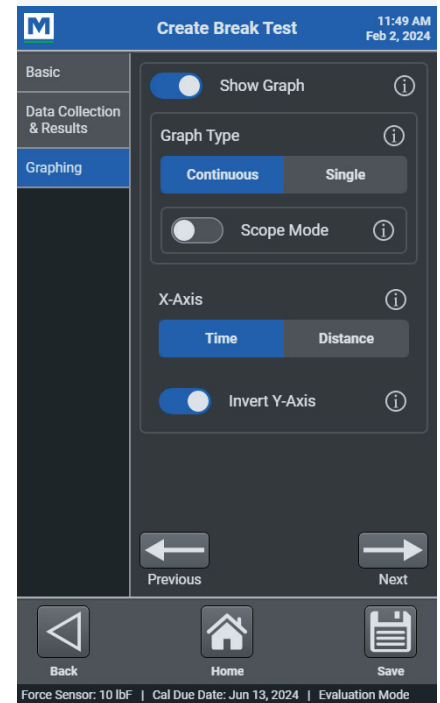
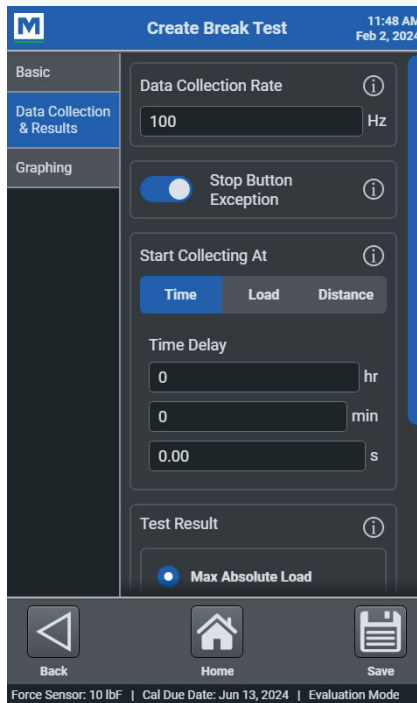
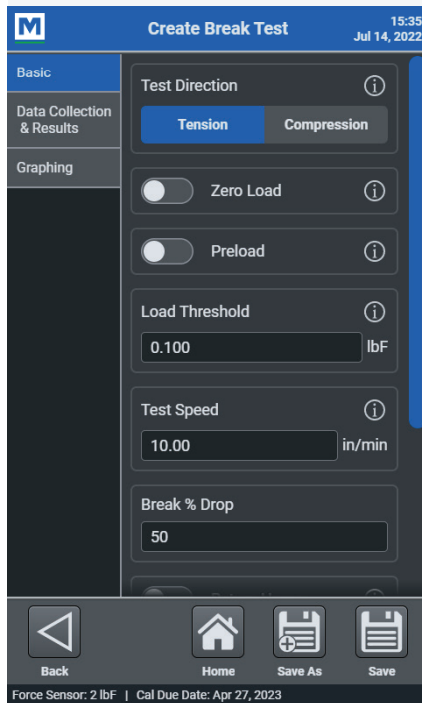

Robust data acquisition and management

Blazingly fast

Force sensor sampling rate of **5,000 Hz** yields accurate peak measurements even in quick-duration events. EasyMESUR® collects load and travel data at up to **100 Hz**, and saves up to **100,000** data points per run.

Customizable reporting

Create a PDF report, including results, statistics, graph, system and user information, and comments. Create report templates to save with future reports.

Save, export, and recall data

Save individual run data or results files to a USB drive or internal storage accessible from a PC.

Data and results may also be exported as .csv files.

Continuous or single point data may be collected on a PC using the UXU100

	A	B	C	D	E	F	G
1	Peel Test - 1 in. Sample						
2							
3	System Information:						
4	EasyMESUR Version: 1.0.0						
5	Test Frame Model: F305						
6	Test Frame Serial Number: 4144714						
7	Test Frame Capacity: 300 lbF / 4800 ozF / 150 kgF / 1500 N / 1.5 kN						
8	Test Frame Firmware Version: 1.09.09						
9	Force Sensor Model: FS05-50						
10	Force Sensor Serial Number: 4081158						
11	Force Sensor Capacity: 50 lbF / 800 ozF / 25 kgF / 25000 gF / 250 N						
12	Force Sensor Calibration Date: Dec 30, 2021						
13	Force Sensor Calibration Due Date: Dec 30, 2022						
14							
15	Run Num	Status	Max Load [lbF]				
16	1	Pass	6.68				
17	2	Pass	7.6				
18	3	Pass	7.16				
19	4	Fail	4.9				

Results .csv output

ABC Manufacturing Company
123 Industrial Drive
Anytown, NY 54321

Peel Test Sample Report

Peel Test - 1 in. Sample

1" wide samples are loaded into G1008 grips. Max load values are recorded for each sample.

System Information:

EasyMESUR Version: 1.00.00
Test Frame Model: F305
Test Frame Serial Number: 4144714
Test Frame Capacity: 300 lbF / 4800 ozF / 150 kgF / 1500 N / 1.5 kN
Test Frame Firmware Version: 1.09.09
Force Sensor Model: FS05-50
Force Sensor Serial Number: 4081158
Force Sensor Capacity: 50 lbF / 800 ozF / 25 kgF / 25000 gF / 250 N
Force Sensor Calibration Date: Dec 30, 2021
Force Sensor Calibration Due Date: Dec 30, 2022

Results

Run Number	Data Context	Status	Max Load [lbF]
1	Load	⊗ Pass	6.68
2	Load	⊗ Pass	7.60
3	Load	⊗ Pass	7.16
4	Load	⊗ Fail	4.90
5	Load	⊗ Pass	7.04

Statistics

Maximum	Minimum	Mean	Standard Deviation	Variance	Area Under Curve
6.68	4.90	6.68	0.936	0.876	33.38

Graph

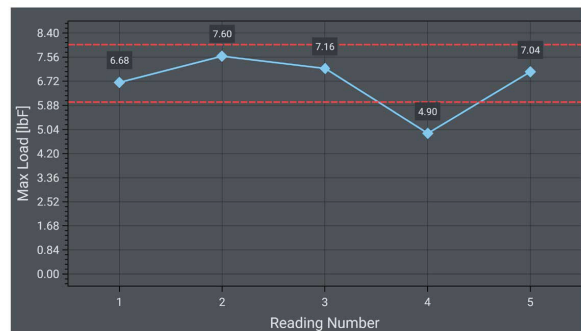

The tests were completed successfully.

PDF report

Tailored to your needs and budget

From basic tests to more advanced needs, EasyMESUR®'s unique optional function platform allows you to select the functions that best suit your requirements.

Any functions not purchased at time of order can be easily enabled in the field via activation codes.

EasyMESUR® systems are shipped in Evaluation Mode, in which all functions are enabled for 160 hours of operation.



Optional functions

Function	Description	Co-requirements
Distance Measurement	Measure distance, with the ability to zero the reading.	-
Distance Limits	Stop at user-defined upper and lower distance limits.	- Distance Measurement
Preload	Zero the travel position automatically at a user-defined preload value.	- Distance Measurement
High Speed Extension	Extend the high end of the speed range, dependent upon test frame model.	-
Low Speed Extension	Extend the low end of the speed range, dependent upon test frame model.	-
Cycling	Set up to 100,000 cycles, with user-defined upper and lower dwell times. Cycle between any combination of limit switches, travel limits, and load limits.	- If cycling to distance limits, add Distance Measurement and Distance Limits
Break Detection	Stop when a user-defined drop in load occurs.	-
Load Holding	Stop at, and maintain, a user-defined load for a specified period of time. For best performance, use a force sensor with a capacity as close as possible to the target load.	-
FollowMe®	Push and pull on the sensor's loading shaft to jog the crosshead up and down, ideal for manual positioning prior to a test. Speed increases with applied force.	-
Graphing & Reporting	Graph load vs. time or distance, view statistics, and generate a report, including graph, results, run data, and other information.	- If graphing load vs. distance, add Distance Measurement
PC Control	Control the test frame with your own application using a supplied library of motion control and data collection serial commands. While PC control is active, the control panel becomes a pendant, limited to basic, manual controls.	- AC1107 cable, test frame to PC
Coefficient of Friction Measurement	Measure static and dynamic coefficients of friction, with user-defined sled weight.	- G1086 coefficient of friction fixture (suggested)
Spring Rate Measurement	Measure spring rate, with user-defined start and stop data collection triggers.	- Distance Measurement - Suggested functions: Distance Limits Preload

Optional function packages

Related functions are combined into available packages.

A complete options package is also offered.

Package	Included Functions
Distance Measurement Package	Distance Measurement, Distance Limits, Preload
Speed Extension Package	High Speed Extension / Low Speed Extension
Advanced Functionality Package	Cycling, Break Detection, Load Holding, FollowMe®
Complete Options Package	All functions

Uniquely serviceable

Calibrate force sensors on the test frame or off-site

Calibrate force sensors in one of two ways:

Test frame

EasyMESUR® provides an integrated utility, with an intuitive step-by-step wizard. Manual controls allow the technician to use the test frame to apply tension and compression forces.

Off-site

Conveniently remove the force sensors for off-site calibration with a Mark-10 Model M7I or M5I indicator.



FS05 force sensor connected to an M5I indicator via AC1083 adapter for off-site calibration

Field-upgradeable

Update the test frame's firmware and EasyMESUR® software in the field via a simple user interface. No need to schedule a service call or to ship hardware to the factory.



Easy-to-service electronics

Most electronics are housed in an integrated module, easily replaced without special tools or processes.

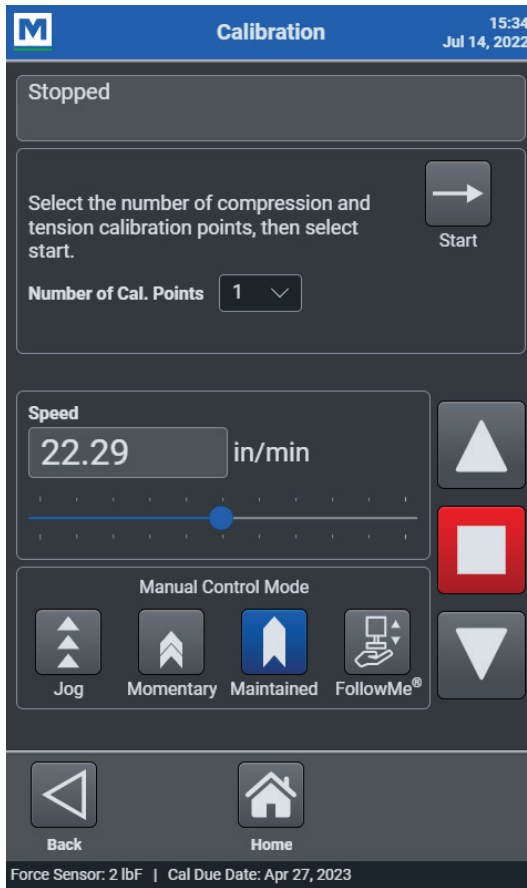

Removing the electronics module



F105 / F305 / F505 / F505H

- Control panel with mounting hardware
- #10-32M medium hook
- 5/16-18M large hook
- #10-32F 2" diameter compression plate
- #10-32 F/F coupler
- Adapter, 5/16-18M to #10-32F
- Set screw, #10-32 x 3/4"
- Hex nut, #10-32 (2)
- Power cord
- Allen wrench set



F755 / F755S / F1505 / F1505S

- Control panel with mounting hardware
- Eye end kit for base
- Lock ring for eye end (2)
- Spanner wrench (2)
- Power cord
- Allen wrench set

Certificate of Calibration - Distance & Speed (CERT-DS)

NIST-traceable certificate of calibration for test frame distance measurement and speed.

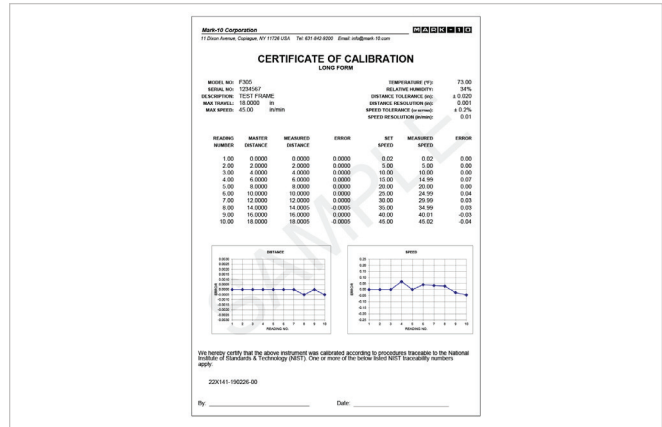

Column Extensions for Models F105 / F305 / F505 / F505H

(AC1094-1, -2, -3, -4, -5, -6, AC1095-1, -2, -3)

Selection of single- and double-column extensions for oversized samples. Three heights are available - 6, 12 and 24 in [150, 300, and 600 mm]. Double-column extensions accommodate up to a 20 in. [508 mm] wide sample, or $\varnothing 21.5$ in [$\varnothing 546$ mm] round sample. Base contains rows of T-slots for fixture mounting. Double column extensions not available for F505H.



Shields (AC1092-1, AC1092-2)

Provide pinch and sample debris protection for the operator. An electrical interlock prevents test frame operation while the door is open. The tablet control panel and included remote emergency stop switch can be mounted to the shield's extruded frame.



USB Cables (AC1116, AC1107)

AC1116 (USB C to A)

Connect the EasyMESUR control panel to a PC for file transfer.

AC1107 (USB B to A)

Connect the test frame to a PC for custom software control via the PC Control option.

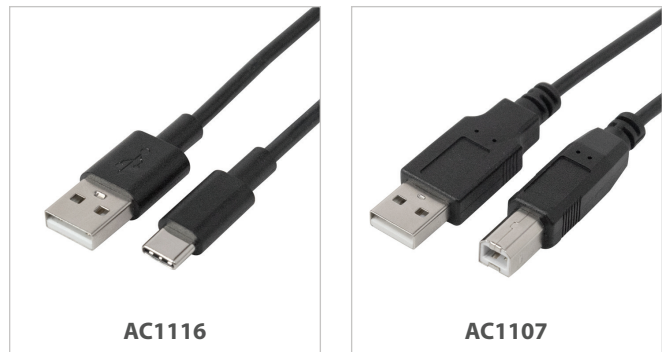

Control Panel Tabletop Mounting Kit (AC1085)

For applications requiring remote use of the control panel. Features an adjustable viewing angle and a base with thru holes for bench mounting.



Adapter, FS05 to Plug & Test® Connector and Extension (AC1083, AC1084)

Adapts a Series FS05 force sensor or PTAF sensor adapter to Plug & Test® type interface, for ease of external calibration via a Mark-10 indicator. Also permits mounting of a Series FS05 sensor to Models F755, F755S, F1505, and F1505S test frames. Shown at right with Model M5I indicator and AC1084 extension cable (12 in / 305 mm).

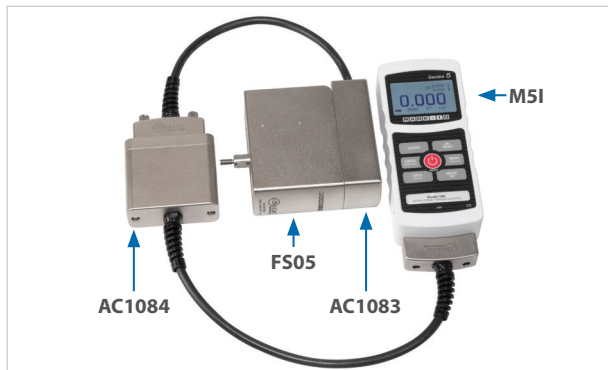

Inversion Plate for Deadweight Calibration on Series F Test Frames (AC1103)

Allows a Series F test frame to be mounted upside-down, permitting both tension and compression calibration of a force sensor with deadweights. Compatible with Series FS05 force sensors, Series FS06 sensors, and models F105, F305, and F505 test frames.

This fixture is not needed for models F755(S) and F1505(S), as force sensors mount to either side of the crosshead, permitting both tension and compression loading with deadweights.

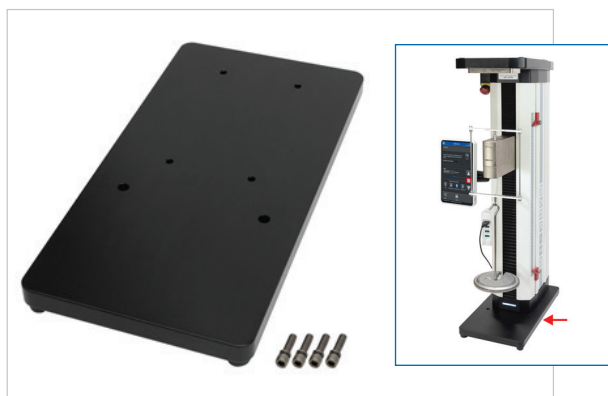

Third-party Force Sensor Adapter (PTAF)

Adapts a user-supplied force sensor to Models F105, F305, F505, and F505H test frames, and Models M5I and M7I indicators. AC1083 adapter required for Models F755, F755S, F1505, and F1505S test frames. Use the included software utility to select from a library of common force capacities. Requires a Model M5I or M7I indicator for configuration.



USB Communication Adapter (UXU100)

Connects the EasyMESUR® control panel to a PC for data collection by a third-party application such as SPC software. Data can be transmitted from the control panel via the Data button or requested from the application via serial commands.



SPECIFICATIONS

	F105-EM	F305-EM	F505-EM	F505H-EM	F755-EM	F755S-EM	F1505-EM	F1505S-EM
Load capacity*:	100 lbF [0.5 kN]	300 lbF [1.3 kN]	500 lbF [2.2 kN]		750 lbF [3.4 kN]		1,500 lbF [6.7 kN]	
Maximum travel:	18.0 in [457 mm]				32.0 in [813 mm]	14.2 in [360 mm]	32.0 in [813 mm]	14.2 in [360 mm]
Standard speed range:	0.5 - 13 in/min [13 - 330 mm/min]				0.5 - 24 in/min [10 - 600 mm/min]			
Optional speed range:	0.02 - 45 in/min [0.5 - 1,100 mm/min]				0.001 - 60 in/min [0.02 - 1,525 mm/min]		0.001 - 70 in/min [0.02 - 1,800 mm/min]	
Load accuracy (% of full scale):	Test frame: $\pm 0.1\%$ Force sensor: Series FS05: $\pm 0.1\%$ Series FS06: $\pm 0.15\%$ Series R07: $\pm 0.15\%$							
Peak sampling rate:	5,000 Hz							
Data acquisition rate:	100 Hz (requires Graphing & Reporting option)							
Speed accuracy:	$\pm 0.2\%$ of setting, virtually no variation with load							
Position accuracy:	± 0.006 in [0.15 mm], at any load or position (requires Distance Measurement option)							
Distance resolution:	0.001 in [0.02 mm] (requires Distance Measurement option)							
Limit switch repeatability:	± 0.001 in [0.03 mm]							
Overload protection:	Motor stops at 120% of full scale of the force sensor							
Power:	Universal input 100-240 VAC, 50/60 Hz, 120W				Universal input 100-240 VAC, 50/60 Hz, 300W		Universal input 100-240 VAC, 50/60 Hz, 450W	
Fuse type:	1.2 A, 250V, 3AG, SLO BLO				4A, 3AG, SLO BLO			
Weight:	60 lb [27 kg]		70 lb [32 kg]		184 lb [83 kg]	149 lb [68 kg]	197 lb [89 kg]	157 lb [71 kg]
Shipping weight:	75 lb [34 kg]		85 lb [39 kg]		235 lb [107 kg]	195 lb [88 kg]	247 lb [112 kg]	205 lb [93 kg]
Environmental conditions:	<ul style="list-style-type: none"> ▪ Indoor use only, up to 6,500 ft [2,000 m] above sea level ▪ Environmental conditions: 40 - 95°F [5 - 35°C], to 80% relative humidity at 31°C, decreasing linearly to 50% relative humidity at 40°C, non condensing ▪ Mains supply voltage fluctuations up to $\pm 10\%$ of the nominal voltage ▪ Transient overvoltages up to the levels of Overvoltage Category II ▪ Use in environments up to Pollution Degree 2 							
Conformance:	CE, UKCA							
Warranty:	3 years [see individual statement for further details]							

* Load capacity is reduced at higher speeds, as follows:

- F305-EM: limited to 200 lbF [1 kN] above 24 in [610 mm]/min
- F505-EM / F505H-EM: limited to 300 lbF [1.3 kN] above 24 in [610 mm]/min
- F755-EM / F755S-EM: limited to 500 lbF [2.3 kN] above 35 in [900 mm]/min
- F1505-EM / F1505S-EM: limited to 1,000 lbF [4.5 kN] above 60 in [1,525 mm]/min

Dimensions in (mm)

Models F105-EM | F305-EM | F505-EM

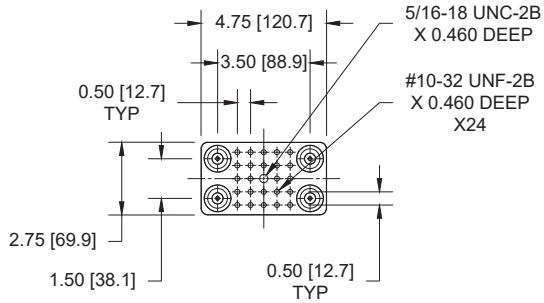
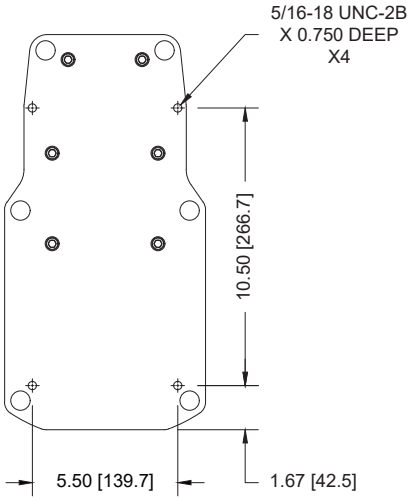
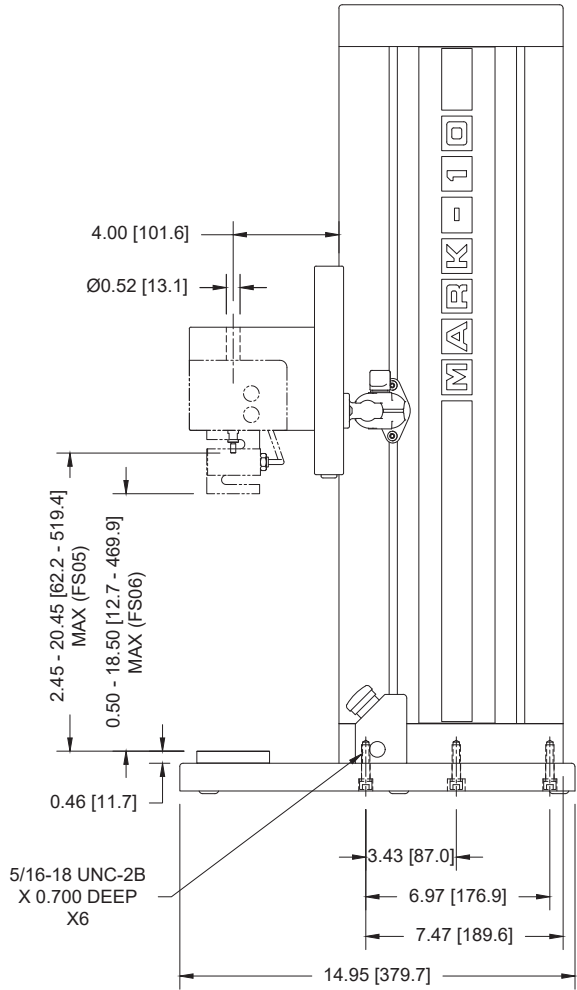
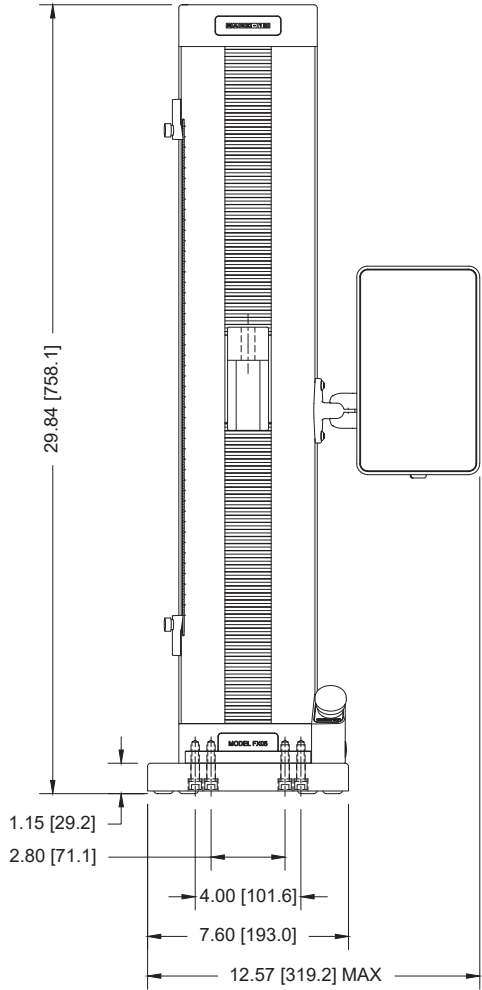

**BENCH MOUNTING HOLES
BOTTOM VIEW**

**MOUNTING PLATE
TOP VIEW**

Model F505H-EM

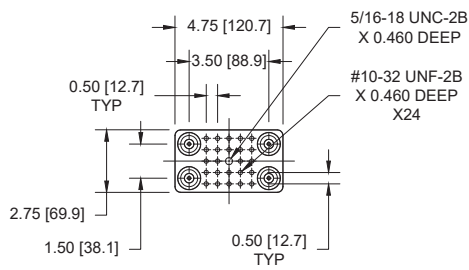
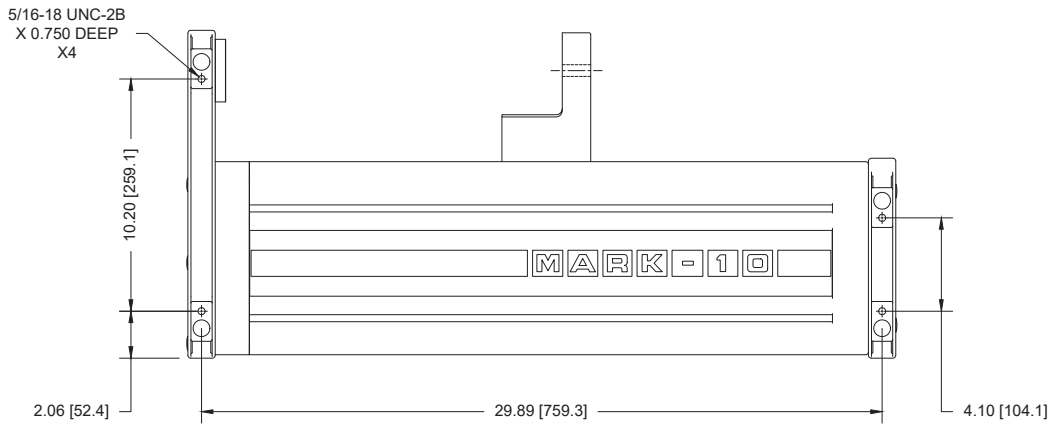
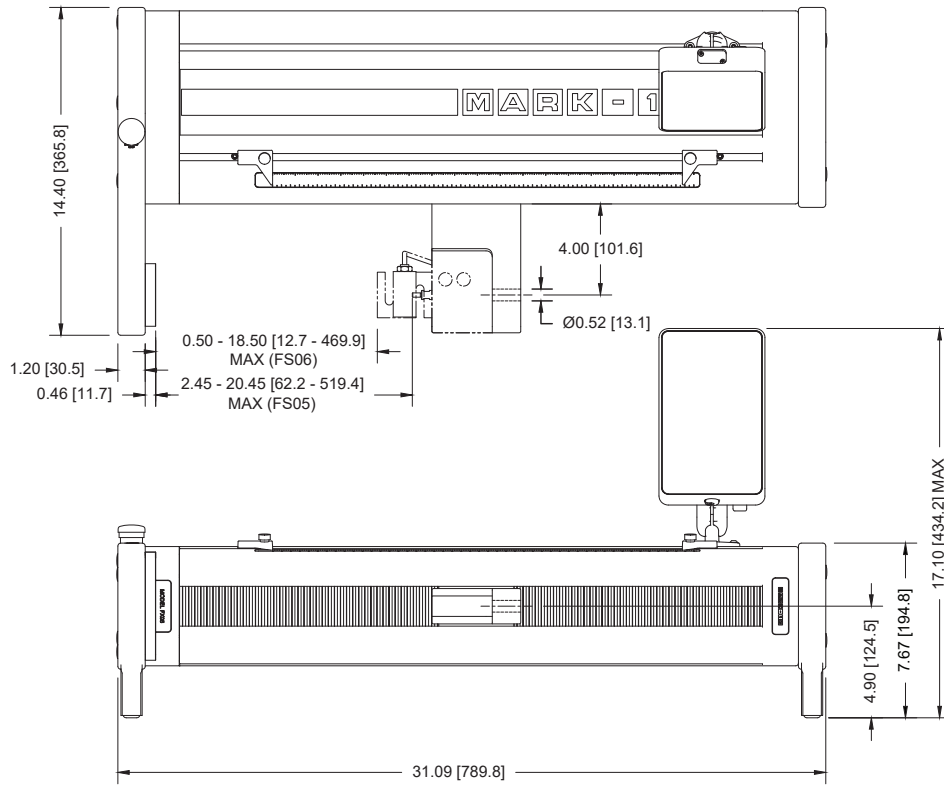

**MOUNTING PLATE
TOP VIEW**

Models F755-EM | F755S-EM | F1505-EM | F1505S-EM

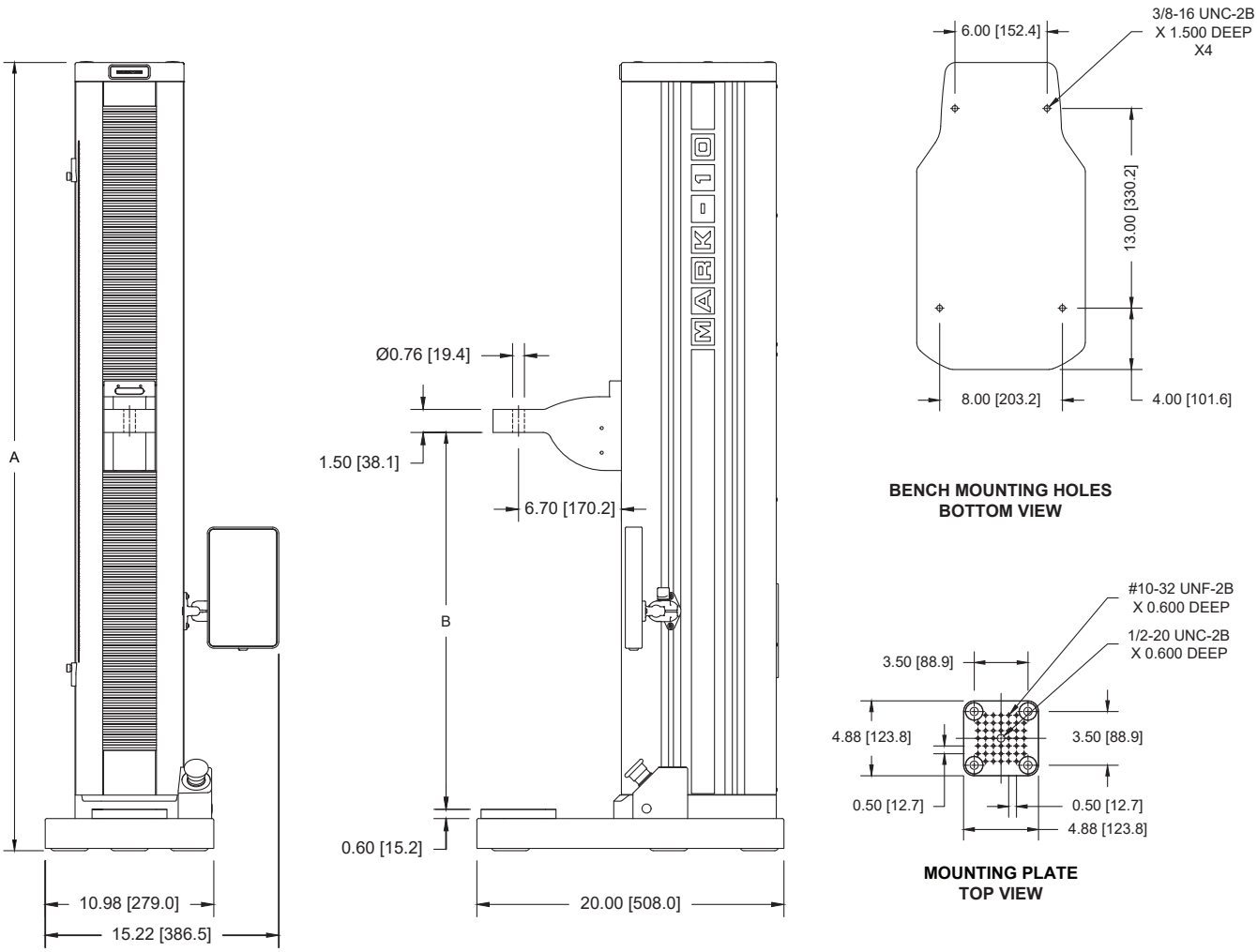

	F755-EM	F755S-EM	F1505-EM	F1505S-EM
A	50.85 [1291.6]	33.39 [848.1]	51.35 [1304.3]	33.89 [860.9]
B	8.13 - 40.13 [206.4 - 1019.2]	8.13 - 22.33 [206.4 - 567.1]	8.13 - 40.13 [206.4 - 1019.2]	8.13 - 22.33 [206.4 - 567.1]

Series FS05 Force Sensors

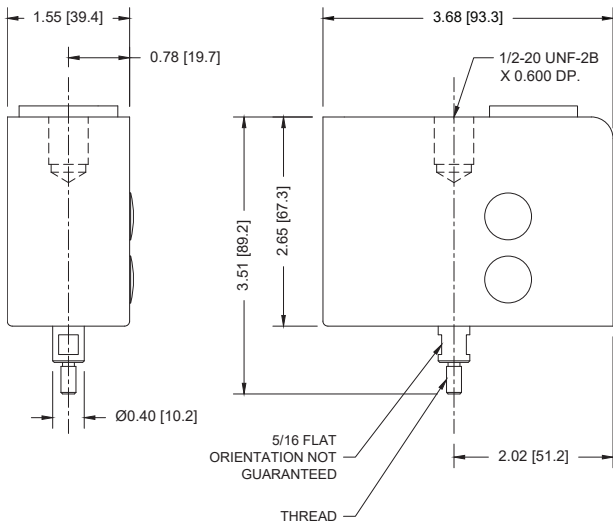

Series FS06 Force Sensors

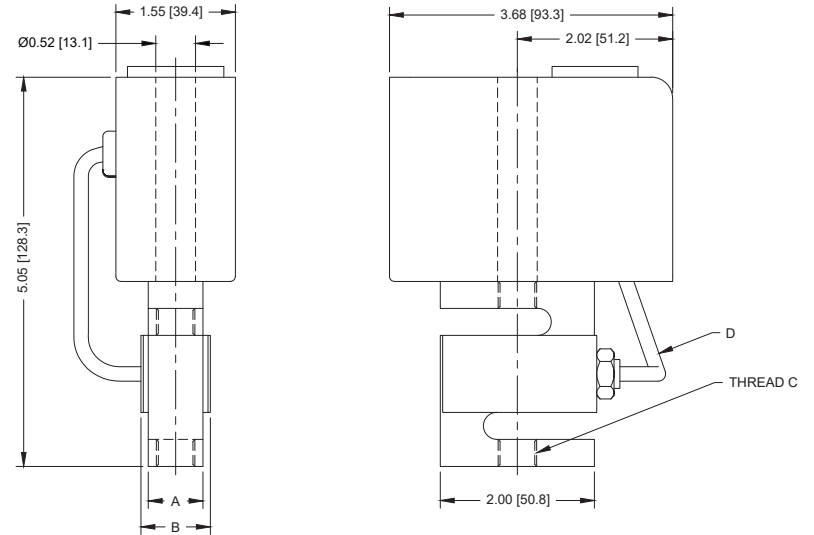

Model No.	Thread
FS05-012 - FS05-100	#10-32 UNF
FS05-200 - FS05-500	5/16-18 UNC

Model No.	A	B	Thread C	D
FS05-012 - FS05-100	0.46 [11.7]	0.71 [18.0]	1/4-28 UNF	6.00 [152.4]
FS05-200 - FS05-500	0.90 [22.6]	1.10 [27.9]	1/2-20 UNF	

Series R07 Force Sensors

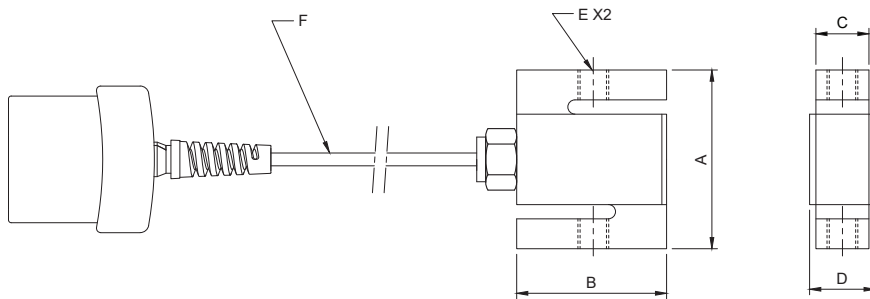

Model No.	A	B	C	D	E	F
MR07-50	2.40 [61.0]	2.00 [50.8]	0.46	0.90	1/4-28	10.00 [254.0]
MR07-100			[11.7]	[22.9]	UNF	
MR07-200						
MR07-300						
MR07-500						
MR07-750						
MR07-1000						
MR07-1500			0.96 [24.4]	1.40 [35.6]	1/2-20 UNF	

Test Frames

Model No.*	Description
F105-EM	Test frame with EasyMESUR® control panel, vertical, 100 lbF / 0.5 kN
F305-EM	Test frame with EasyMESUR® control panel, vertical, 300 lbF / 1.3 kN
F505-EM	Test frame with EasyMESUR® control panel, vertical, 500 lbF / 2.2 kN
F505H-EM	Test frame with EasyMESUR® control panel, horizontal, 500 lbF / 2.2 kN
F755-EM	Test frame with EasyMESUR® control panel, vertical, 750 lbF / 3.4 kN
F755S-EM	Test frame with EasyMESUR® control panel, vertical, short, 750 lbF / 3.4 kN
F1505-EM	Test frame with EasyMESUR® control panel, vertical, 1,500 lbF / 6.7 kN
F1505S-EM	Test frame with EasyMESUR® control panel, vertical, short, 1,500 lbF / 6.7 kN

* All test frame models contain a universal power supply (80 - 240V) and power cord with 110V US prong style. Add suffix 'E' for 220V European prong, 'U' for 220V UK prong, or 'A' for 220V Australian prong. Ex: F505-EME.

Optional Functions and Function Packages

Model No.*	Description
EMF001-1 / EMF001-2	Distance Measurement
EMF002-1 / EMF002-2	Distance Limits
EMF003-1 / EMF003-2	Preload
EMF004-1 / EMF004-2	High Speed Extension
EMF005-1 / EMF005-2	Low Speed Extension
EMF006-1 / EMF006-2	Cycling
EMF007-1 / EMF007-2	Break Detection
EMF008-1 / EMF008-2	Load Holding
EMF009-1 / EMF009-2	FollowMe®
EMF010-1 / EMF010-2	Graphing & Reporting
EMF011-1 / EMF011-2	PC Control
EMF012-1 / EMF012-2	Coefficient of Friction Measurement
EMF013-1 / EMF013-2	Spring Rate Measurement
EMP001-1 / EMP001-2	Distance Measurement Package
EMP002-1 / EMP002-2	Speed Extension Package
EMP003-1 / EMP003-2	Advanced Functionality Package
EMP-COMP-1 / EMP-COMP-2	Complete Options Package

* -1 applies to F105, F305, F505, and F505H. -2 applies to F755, F755S, F1505, and F1505S

Series FS05 Force Sensors

Compatible with Models F105, F305, F505, and F505H.

Adapter part no. AC1083 is required for Models F755, F755S, F1505, and F1505S.



Model No.	Capacity x Resolution						
	lbF	ozF	gF	kgF	N	kN	mN
FS05-012	0.12 x 0.00002	2 x 0.0005	50 x 0.01	-	0.5 x 0.0001	-	500 x 0.1
FS05-025	0.25 x 0.0001	4 x 0.002	100 x 0.05	-	1 x 0.0005	-	1000 x 0.5
FS05-05	0.5 x 0.0002	8 x 0.005	250 x 0.1	-	2.5 x 0.001	-	2500 x 1
FS05-2	2 x 0.001	32 x 0.02	1000 x 0.5	1 x 0.0005	10 x 0.005	-	-
FS05-5	5 x 0.002	80 x 0.05	2500 x 1	2.5 x 0.001	25 x 0.01	-	-
FS05-10	10 x 0.005	160 x 0.1	5000 x 2	5 x 0.002	50 x 0.02	-	-
FS05-20	20 x 0.01	320 x 0.2	10000 x 5	10 x 0.005	100 x 0.05	-	-
FS05-50	50 x 0.02	800 x 0.5	25000 x 10	25 x 0.01	250 x 0.1	-	-
FS05-100	100 x 0.05	1600 x 1	50000 x 20	50 x 0.02	500 x 0.2	-	-
FS05-200	200 x 0.1	3200 x 2	-	100 x 0.05	1000 x 0.5	1 x 0.0005	-
FS05-300	300 x 0.1	4800 x 2	-	150 x 0.05	1500 x 0.5	1.5 x 0.0005	-
FS05-500	500 x 0.2	8000 x 5	-	250 x 0.1	2500 x 1	2.5 x 0.001	-

Series R07 Force Sensors

Compatible with Models F755, F755S, F1505, and F1505S.

Cannot be used with Models F105, F305, F505, and F505H.

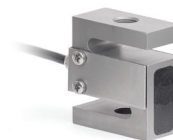

Model No.	Capacity x Resolution					
	lbF	ozF	gF	kgF	N	kN
MR07-50	50 x 0.02	800 x 0.5	25000 x 10	25 x 0.01	250 x 0.1	-
MR07-100	100 x 0.05	1600 x 1	50000 x 20	50 x 0.02	500 x 0.2	-
MR07-200	200 x 0.1	3200 x 2	-	100 x 0.05	1000 x 0.5	1 x 0.0005
MR07-300	300 x 0.2	4800 x 5	-	150 x 0.1	1500 x 1	1.5 x 0.001
MR07-500	500 x 0.2	8000 x 5	-	250 x 0.1	2500 x 1	2.5 x 0.001
MR07-750	750 x 0.5	12000 x 10	-	375 x 0.2	3750 x 2	3.75 x 0.002
MR07-1000	1000 x 0.5	16000 x 10	-	500 x 0.2	5000 x 2	5 x 0.002
MR07-1500	1500 x 1	24000 x 20	-	750 x 0.5	7500 x 5	7.5 x 0.005

Series FS06 Force Sensors

Compatible with Models F105, F305, F505, and F505H.



Model No.	Capacity x Resolution					
	lbF	ozF	gF	kgF	N	kN
FS06-50	50 x 0.02	800 x 0.5	25000 x 10	25 x 0.01	250 x 0.1	-
FS06-100	100 x 0.05	1600 x 1	50000 x 20	50 x 0.02	500 x 0.2	-
FS06-200	200 x 0.1	3200 x 2	-	100 x 0.05	1000 x 0.5	1 x 0.0005
FS06-300	300 x 0.2	4800 x 5	-	150 x 0.1	1500 x 1	1.5 x 0.001
FS06-500	500 x 0.2	8000 x 5	-	250 x 0.1	2500 x 1	2.5 x 0.001

Optional Equipment

Model No.	Description
CERT-DS	Certificate of calibration, distance and speed
AC1116	USB cable, control panel to PC
AC1107	USB cable, test frame to PC
AC1094-1	Single column extension, 6 in / 150 mm, F105 / F305 / F505
AC1094-2	Single column extension, 12 in / 300 mm, F105 / F305 / F505
AC1094-3	Single column extension, 24 in / 600 mm, F105 / F305 / F505
AC1094-4	Single column extension, 6 in / 150 mm, F505H
AC1094-5	Single column extension, 12 in / 300 mm, F505H
AC1094-6	Single column extension, 24 in / 600 mm, F505H
AC1095-1	Double column extension, 6 in / 150 mm, F105 / F305 / F505
AC1095-2	Double column extension, 12 in / 300 mm, F105 / F305 / F505
AC1095-3	Double column extension, 24 in / 600 mm, F105 / F305 / F505
AC1092-1	Shield, F755 / F1505 and F105 / F305 / F505 with column extensions up to 24 in / 600 mm
AC1092-2	Shield, F755S / F1505S and F105 / F305 / F505 without column extensions
AC1083	Adapter, FS05 sensor / PTAF adapter, to Plug & Test® connector / F755, F755S, F1505, F1505S test frames, 10 in / 250 mm cable
AC1084	Extension cable, 24 in / 610 mm, Plug & Test®, male/female
AC1130	Inversion plate for deadweight calibration on Series F test frames
PTAF	Adapter, Plug & Test®, customer-supplied force sensor to Series F test frames

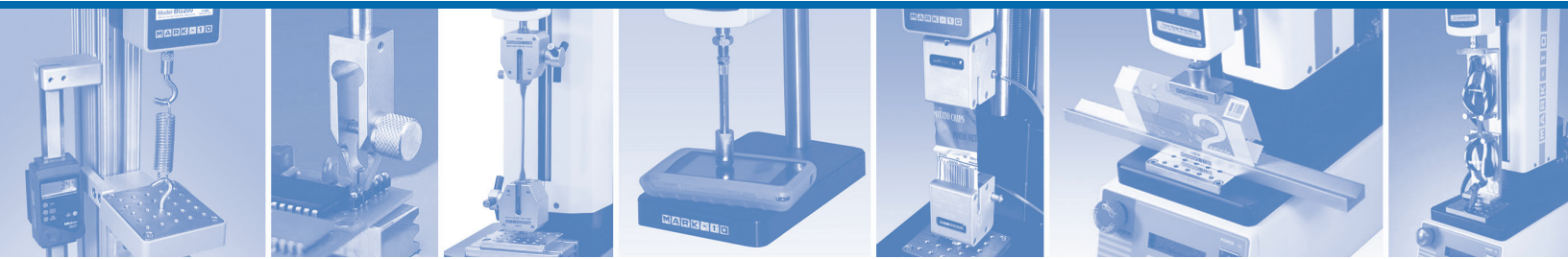

Applications are virtually limitless...

Mark-10 force and torque measurement products help quality control, engineering, and manufacturing professionals assess and ensure quality in virtually every industry worldwide.



Automotive



Aerospace

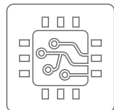

Electronics



Consumer
Products



Springs

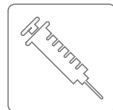

Medical
Device



Packaging



Food &
Beverage



Ergonomics

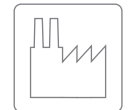

Other
Industries

MARK-10

Force and Torque Measurement Engineered Better

Mark-10 Corporation
11 Dixon Avenue ■ Copiague, NY 11726 USA
888-MARK-TEN ■ Tel: +1 631 842 9200 ■ Fax: +1 631 842 9201
www.mark-10.com ■ info@mark-10.com



© 2024 Mark-10 Corporation
32-1256
0224