

Series **CG**

HIGH CAPACITY DIGITAL FORCE GAUGES

User's Guide

MARK-10®

Thanks You!

Thank you for purchasing a Mark-10 Series CG Digital Force Gauge. We are confident that you will get many years of great service from this product.

Mark-10 digital force gauges are designed to be easy to use and ruggedly constructed for many years of service in laboratory and industrial environments.

This User's Guide provides setup, operating, and programming instructions. Dimensions and specifications are also provided. For additional information or answers to your application questions, contact us and our technical support and engineering teams will be eager to help you.

Thank you again for your purchase and happy testing!

TABLE OF CONTENTS

GENERAL	3
Controls	3
Orientation.....	3
Mounting	4
POWER	4
CONFIGURATION	4
FILTERS	7
EXTERNAL TRIGGER MODE	7
SET POINTS	8
AVERAGE MODE	8
GAUGE CONTROL LANGUAGE	9
OUTPUTS	11
RS-232	11
Mitutoyo BCD	11
Analog	11
I/O Pin Connector Diagram	11
CALIBRATION	12
SPECIFICATIONS	12
General	12
Capacity x graduation	12
DIMENSIONS	13
WARRANTY	13

1 GENERAL

Controls

Six keys on the front panel are used for all functions and control of the instrument. Some have more than one function, depending on the mode of operation. The main functions are labeled above the keys and the secondary functions are below the keys in smaller type. In the list below the secondary functions are in parenthesis. For a detailed description of the secondary functions see Section 3.

POWER(ENTER)	Turns power on and off
UNITS (▲)	Selects units of measurement
ZERO (▼)	Zeroes any tare value (up to the full capacity of the Instrument) and clears the peak readings
DATA	Initiates a data transmission sequence
MODE(ADVANCE)	Switches the display between normal and peak modes of operation
CLEAR(ESCAPE)	Clears peak readings from memory

Orientation

In order to accommodate a variety of testing requirements the orientation of the loading surface may be set up in either of the two positions shown below. Follow the instructions below to change the loading surface orientation:

1. Remove the four screws in the rear housing
2. Separate the front and rear housings
3. Remove the two inside screws, separating the front housing and front panel assembly, as depicted below
4. Rotate the front panel assembly 180°
5. Reassemble the front housing and front panel assembly
6. Attach to the rear housing, and retighten the four screws

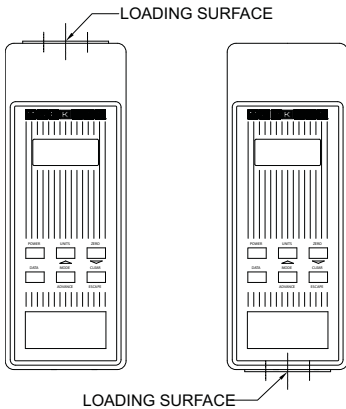

Upright Orientation
(as supplied)

Alternate Orientation
(for test stand
mounting, etc.)

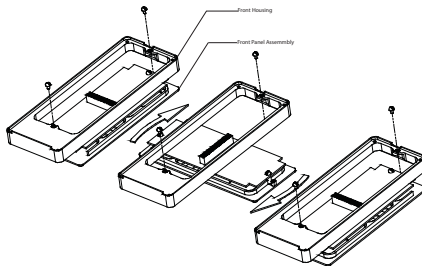

Mounting

To mount the gauge to a Mark-10 test stand, line up the 1/4" hole in the gauge's housing with the protruding dowel pin in the gauge plate. Then, fasten four thumb screws through the gauge plate into the gauge housing.

Gauge shown mounted
on a Model TSF test stand

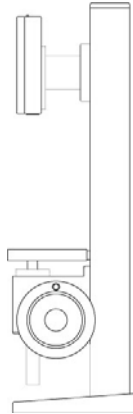

2 POWER

The gauge is powered by a 7.2-volt NiCd rechargeable battery. Since batteries are subject to self-discharge, it may be necessary to recharge the unit after a prolonged period of storage. Plug the accompanying charger into the AC outlet and insert the charger plug into the receptacle on the gauge. The gauge may be operated for 8-10 hours after approximately 16-18 hours of charging. **Do not use chargers other than supplied or instrument damage may occur.**

There are three levels of low battery voltage indication. At the first level, the display shows a steady "LO BAT" indicating approximately one hour of charge remaining. The second level is indicated by a flashing "LO BAT". At the third level, the whole display except the "LO BAT" indicator will flash for three seconds after which time the gauge will turn itself off. This prevents the instrument from working at voltages too low for reliable operation.

3 CONFIGURATION

Series CG gauges have several features with programmable options allowing many user-specified choices. In order to access the configuration menu, perform the following:

1. Turn off the gauge
2. Press and hold MODE
3. Turn on the gauge
4. Release MODE

The software version number will be displayed for a short time followed by "FLtA". The following secondary functions of keys are used during the configuration process.

ADVANCE	Step through menu choices
ENTER	Select a menu choice
ESCAPE	Quit any function (no change)
▲ & ▼	Increment or decrement displayed values

The following list shows all configuration options. *Italics indicate factory settings.*

FLtA - Analog filter

FA 0	2.5 Hz RC filter disabled
FA 1	2.5 Hz RC filter enabled

FLTd - Digital filters

FC 1	No filtering of current (displayed) readings
FC 2	Average of 2 samples for each reading
FC 4	Average of 4 samples for each reading
FC 8	Average of 8 samples for each reading
FP 1	No filtering of peak readings
FP 2	Average of 2 samples for each peak reading
FP 4	Average of 4 samples for each peak reading
FP 8	Average of 8 samples for each peak reading

232 - RS-232 settings

232D	Output disabled
232E	Output Enabled
300	300 baud
600	600 baud
1,200	1,200 baud
2,400	2,400 baud
4,800	4,800 baud
9,600	9,600 baud
7-1E	7 data bits, 1 stop bit, even parity
7-1o	7 data bits, 1 stop bit, odd parity
7-2E	7 data bits, 2 stop bits, even parity
7-2o	7 data bits, 2 stop bits, odd parity
7-2n	7 data bits, 2 stop bits, no parity
8-1E	8 data bits, 1 stop bit, even parity
8-1o	8 data bits, 1 stop bit, odd parity
8-1n	8 data bits, 1 stop bit, no parity
8-2n	8 data bits, 2 stop bits, no parity
Ft F	Full data (numeric + units)
Ft n	Numeric data only

out - Outputs selection (other than RS-232)

SP d	Set point outputs disabled
SP E	Set point outputs enabled
bcd d	Mitutoyo BCD output disabled
bcd E	Mitutoyo BCD output enabled
nPOL	Mitutoyo readings without polarity (absolute value)
POL	Mitutoyo readings with polarity; positive for compression, negative for tension
Et d	External trigger disabled
Et E	External trigger enabled in edge mode
Et L	External trigger enabled in level mode
EtHL	Data capture during high to low transition of trigger signal
EtLH	Data capture during low to high transition of trigger signal

Aout - Automatic output (RS-232)

no	Automatic output disabled
1	Every sample transmitted
2	Every 2nd sample transmitted
4	Every 4th sample transmitted
8	Every 8th sample transmitted
16	Every 16th sample transmitted
32	Every 32nd sample transmitted
64	Every 64th sample transmitted
128	Every 128th sample transmitted

AoFF - Automatic shutoff settings

no	Disabled
1	1-minute automatic shutoff
5	5-minute automatic shutoff
10	10-minute automatic shutoff
20	20-minute automatic shutoff
30	30-minute automatic shutoff

init - Initial (default) settings

LB	Pounds as default units
KG	Kilograms as default units
N	Newtons as default units
A	Average mode at turn on
EtE/EtL	External trigger mode at turn on
TC	Real time display at turn on
PEAK T	Peak tension display at turn on
PEAK C	Peak compression display at turn on

A - Average mode settings

A E	Average mode enabled
A d	Average mode disabled
dEL	Initial delay prompt
At	Average time prompt
trF	Trigger force value prompt

CAL- CALIBRATION. See Section 10.

4 FILTERS

For maximum flexibility in noise suppression and peak capturing ability of the instrument, there are two types of filters available to the user: analog and digital.

The analog filter is a simple RC network with a cutoff frequency of 2.5 Hz and attenuation of 20 dB/decade. It can be either turned on or off.

The digital filter utilizes the moving average technique in which consecutive readings are "pushed" through a buffer and the displayed reading is the average of the buffer contents. By varying the length of the buffer, a variable smoothing effect can be achieved. The CG is equipped with a buffer which can hold up to eight readings. The number of readings to be averaged can be set to 1,2,4 or 8. The selection of 1 will disable the filter since the average of a single value is the value itself.

The analog and the digital filters should be disabled or set to their minimum acceptable values for highest peak capture speed.

5 EXTERNAL TRIGGER MODE

This mode of operation is useful for measuring electrical contact activation force as well as synchronization of multiple instruments for a "snap-shot" view of applied forces. When this mode is enabled through the configuration menu (see Section 3), the MODE key will sequence through an additional state which is indicated by the flashing "C" or "T" indicator.

When in this mode, the instrument stops updating the display when the trigger signal is applied. It is possible to capture the reading with a normally open contact (high to low transition of the trigger signal) or a normally closed contact (low to high transition).

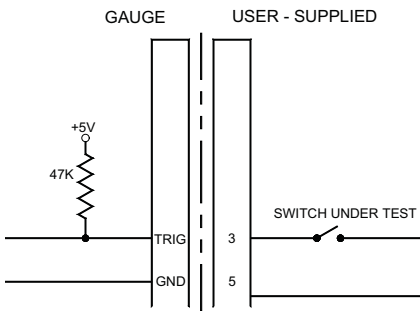

The display will show the captured reading until ZERO or CLEAR is pressed if the "edge" mode is set. The "level" mode provides for the display to hold the reading only until the trigger signal returns to its original state.

Please refer to the diagram for connection details and to Section 3 for configuration information.

6 SET POINTS

This feature is useful for tolerance checking (GO/NO GO) or alarm indication in process control applications. Two limits, high and low, are specified and stored in the non-volatile memory of the instrument and all readings are compared to these limits. The results of the comparisons are indicated through the three open-collector outputs provided on the 9-pin connector, thus providing "under", "in range" and "over" signaling. These outputs can be connected to indicators, buzzers or relays as required for the application.

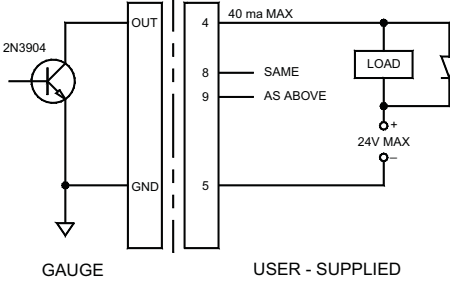

After the Set Point mode is enabled through the configuration menu (see Section 3), pressing the MODE key will sequence through an additional step indicated by "SP" on the display. To enter or change the values of the set points press ENTER. The high set point is

displayed. Use the ▲ and ▼ keys to increase or decrease the value and MODE for changing between tension and compression. When the desired value is displayed, press ENTER and repeat the above steps for the low set point. After entering both values "donE" will appear on the display. Press ENTER to store the changes or ESCAPE to quit. In either case "SP" will appear on the display and the ENTER key may be used for re-entering the set point change mode or the MODE key for proceeding with the normal operation of the gauge.

7 AVERAGE MODE

This mode is used for obtaining an average force reading over a specified period of time. Applications include measurement of peel force, muscle strength, frictional force and any other tests requiring time-averaged readings. There are three user-programmable parameters associated with this mode: trigger force, initial delay and average time. The programming of these parameters and the enabling of the Average mode are done during the gauge setup. Please refer to the "Configuration" section for more information.

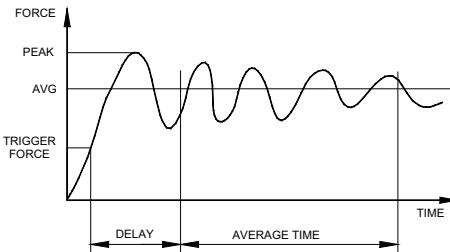

Press MODE until "A" is displayed and then CLEAR or ZERO to begin testing. The process of averaging begins as soon as the programmed trigger force is reached and is indicated by a flashing "A". The conclusion of the test is indicated by

an alternating "A" and the calculated value. The readings obtained during the initial delay will not be part of the average, but the peak value is stored for later recall. A new test may be started by pressing CLEAR or ZERO.

8 GAUGE CONTROL LANGUAGE

The instrument can be controlled by an external device through the RS-232 channel. The following is a list of supported commands and their interpretations. All commands must be terminated with a Carriage Return character (hex 0D) or with a Carriage Return/Line Feed combination (hex 0D+0A). The gauge responses are always terminated with a Carriage Return/Line Feed.

A	Enable Average mode
AD	Disable Average mode
AM	Select Average mode (if enabled)
ATn	Average time. n=0.1-300.0 seconds
DELn	Initial delay. n=0.1-300.0 seconds
TRFn	Trigger force. n=value (+ for compression, - for tension)
SP	Enable Set Point mode
SPD	Disable Set Point mode
SPHn	High set point. n=value (+ for compression, - for tension)
SPLn	Low set point. n=value (+ for compression, - for tension)
AOFFn	Auto-shutoff. n=0,1,5,10,20,30 minutes. 0=always on
AOUTn	Auto-transmit every nth reading. n=0,1,2,4,8,16,32,64,128. 0=disabled
LB	Switch units to pounds
KG	Switch units to kilograms
N	Switch units to Newtons
G	Switch units grams
ET	Enable External trigger mode
ETD	Disable External trigger mode
ETE	Edge triggered External trigger mode
ETL	Level triggered External trigger mode
HL	Reading captured on a high to low transition
LH	Reading captured on a low to high transition
CUR	Current mode (real time display)
PT	Peak Tension mode
PC	Peak Compression mode
CLR	Clear peaks, start a new average, or external trigger test
Z	Zero display and perform the CLR function
?	Request the displayed reading
?C	Request the current reading
?PT	Request the peak tension reading
?PC	Request the peak compression reading
?ET	Request the reading obtained during the external trigger mode
?A	Request the average reading obtained during the Average mode
FLTCn	Digital filter for current (displayed readings). n=1,2,4,8
FLTPn	Digital filter for peak readings. n=1,2,4,8

Series CG Digital Force Gauge

FLTA _n	Analog filter (2.5 Hz). n=1,2. 1=on, 0=off
FULL	RS-232 transmission with units
NUM	RS-232 transmission without units (only numeric values)
MIT	Enable Mitutoyo output
MITD	Disable Mitutoyo output
POL	Mitutoyo outputs with polarity. (+ for compression, - for tension)
NPOL	Mitutoyo outputs without polarity (absolute value)
PM	Print/send data to a Mitutoyo compatible device
Sn	Set output bit (open collector, pull to ground). n=0,1,2
Cn	Clear output bit. n=0,1,2
Rn	Read current status of output bit or level of input pin. n=0,1,2,3
SAVE	Save current settings in nonvolatile memory
CAL	Enter Calibration mode. See Section 10 for more information
LIST	List current settings and status. Here is a typical LIST output: V3.00;LB;PC;FLTC8;FLTP1;FLTA1;AOUT00;AOFF05 FULL;MIT;POL;B0 All fields are separated by ";". The first field shows the software version, the last field shows the remaining battery power (B0=full charge, B3=minimum power). All other fields show the status of settings and features using the same abbreviations as the commands to set them.

Any detected errors are reported back by means of the following error codes.

*10	Illegal command
*11	Not applicable; e.g. SPH _n command without enabling the set points
*21	Invalid specifier; e.g. AOFF2
*22	Value too large
*30	Calibration weight too high
*31	Calibration weight too low
*50	Communication error
*51	Command string too long

Following is a sample BASIC program illustrating the use of some commands. It switches the units to kilograms and sets the display to zero. Press any key to get a reading on the screen. Use "ESC" to exit the program.

```
10 CLS: OPEN "COM1:9600,N,8,1,RS,CS,DS,CD,LF" AS #1
20 PRINT #1 "KG"
30 PRINT #1 "Z"
40 PRINT "PRESS ANY KEY FOR READING OR
<ESC> TO EXIT"
50 KEYPR$=INKEY$: IF KEYPR$="" THEN 50
60 IF KEYPR$=CHR$(27) THEN SYSTEM
70 PRINT #1 "?"
80 LINE INPUT #1,A$
90 PRINT A$
100 GOTO 40
```

9 OUTPUTS

RS-232

The data transmission can be initiated by pressing the DATA key or by an external device by sending ASCII "?" to the gauge. The gauge will respond by sending the current reading in either full or numeric format, depending on the configuration settings (see Section 3). Polarity sign indicates tensile (-) or compressive (+) forces. The transmitted string has the following format:

[POLARITY (SPACE OR -)][DATA][SPACE][UNITS (IF ENABLED)][CRLF]

The display will flash "Err" and no data will be transmitted if DATA is pressed during the average computation while in the Average mode or during the input scanning in the External trigger mode.

Mitutoyo BCD

This output is useful for connection to data collectors, printers, multiplexers or any other device capable of accepting Mitutoyo BCD data. The transmission is initiated by the DATA key or by the receiving device (see Section 3 for settings).

Analog

This output can be used for chart recorders, oscilloscopes, data acquisition systems, or any other compatible devices with analog inputs. The output produces ± 1 volt at full scale of the instrument. The polarity of the signal is positive for compression and negative for tension.

I/O connector pin diagram

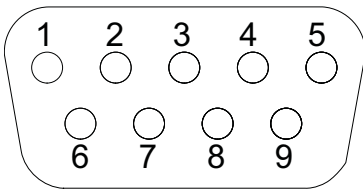

DB-9P

1	RS-232 receive	Input
2	RS-232 transmit	Output
3	Mitutoyo request	Input
	External trigger	"
	Input bit 3	"
4	Mitutoyo clock	Output
	"Within" set point output	"
	Output bit 2	"
5	Signal ground	---
6	+Analog Signal	Output
7	+12V DC	Output
8	Mitutoyo ready	Output
	"Under" set point output	"
	Output bit 1	"
9	Mitutoyo data	Output
	"Over" set point output	"
	Output bit 0	"

10 CALIBRATION

Mount the gauge firmly with the loading surface directed downward. Go into the configuration mode as described in the previous section and select the calibration sub-menu by pressing ENTER three times when the display shows 'CAL'. After the display shows 'null' press ZERO, while insuring that there is no weight on the loading surface other than the weight of the required attachments (hooks, etc.). The next displayed prompt is 'SPAN' at which time apply the exact weight equal to the **full capacity of the gauge in pounds** and press ENTER. A successful calibration procedure is indicated by 'donE' on the display. Press ENTER to save the new calibration data and to return to normal operation. In some cases the display will show 'nnnn' or 'uuuu' to indicate excessive or insufficient calibration weight. This can be caused by incorrect weights, tare weight of over 10% of the full capacity of the gauge or an overloaded sensor. The calibration procedure may be aborted without changing the previous calibration information at any time by pressing ESCAPE.

11 SPECIFICATIONS

General

Accuracy	±0.2% of full scale, ±1 count		
Tare capacity	110% of capacity. Display shows "----" at 110%		
Overload capacity	150% of capacity. Display shows "----" at 110%		
Sampling rate	65 samples per second		
Display update	2.5-10 times per second in normal model depending on filter settings. 65 times per second in peak mode		
Display	4-1/2-character LCD 0.3" [7.6 mm] high		
Load cell deflection	Maximum 0.010" [0.25 mm] at full scale		
Outputs			
RS-232	Baud rates between 300 and 9600		
Mitutoyo	Standard Mitutoyo SPC BCD output		
Analog	±1 VDC ±0.25% FS		
Connector	9-pin D-type male		
Power	7.2 NiCd battery or included AC adapter/charger		
Battery life	8-10 hours per charge		
Weight	1.8 lbs [0.8 kg]		

Capacity x graduation

CG500	500.0 x 0.2 lbF	250.0 x 0.1 kgF	2500 x 1 N
CG1000	1000.0 x 0.5 lbF	500.0 x 0.2 kgF	5000 x 2 N

12 DIMENSIONS

in [mm]

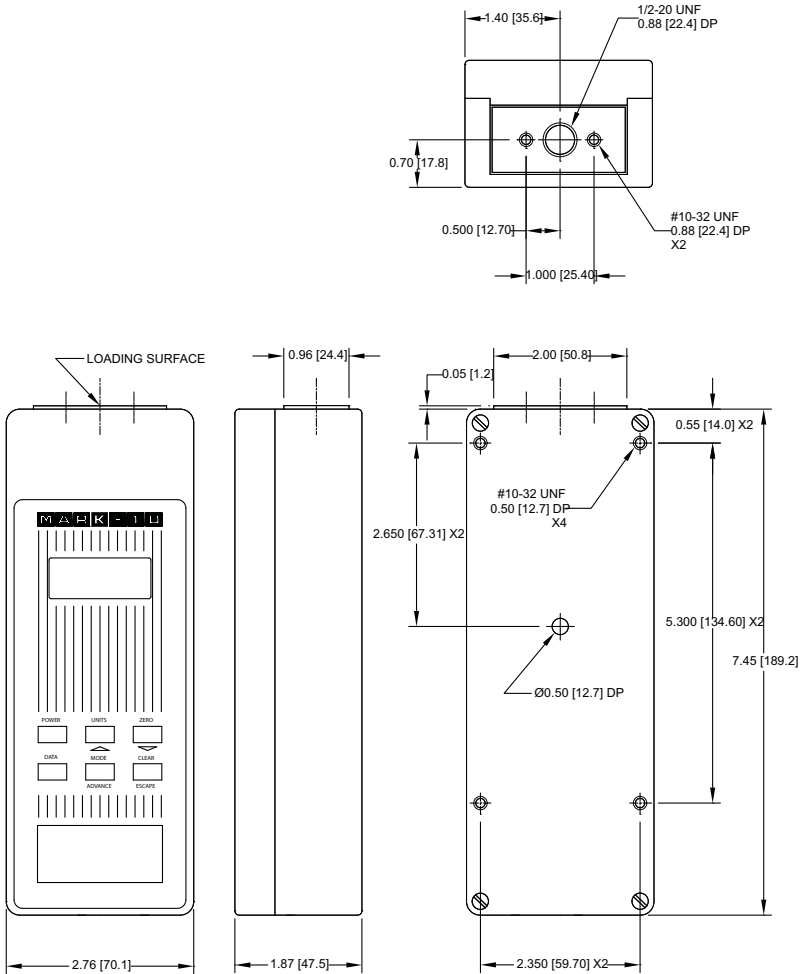

13 WARRANTY

Mark-10 Corporation expressly warrants to its buyer for three (3) years from the date of delivery that the goods sold are free from defects in workmanship and materials. Mark-10 Corporation will, at its option, repair or replace or refund the purchased price of goods found to be defective. This remedy shall be the buyer's sole and exclusive remedy. Any modification, abuse, exposure to corrosive environment or use other than intended will void this warranty. This warranty is in lieu of all other warranties, including implied warranties of merchantability and fitness for an intended purpose. In no event shall Mark-10 Corporation be liable for any incidental and consequential damages in connection with goods sold or any part thereof.



Mark-10 Corporation has been an innovator in the Force and Torque measurement fields since 1979. We strive to achieve 100% customer satisfaction through excellence in product design, manufacturing and customer support. In addition to our standard line of products we can provide modifications and custom designs for OEM applications. Our engineering team is eager to satisfy any special requirements. Please contact us for further information or suggestions for improvement.



We make a measurable difference in force and torque measurement

Mark-10 Corporation

11 Dixon Avenue
Copiague, NY 11726 USA
1-888-MARK-TEN
Tel: 631-842-9200
Fax: 631-842-9201
Internet: www.mark-10.com
Email: info@mark-10.com