



Series FS05 force sensors measure tension and compression force, and are designed for use with Series F test frames. Capacities available from 0.12 to 500 lbf [0.5 N to 2.5 kN]. Also compatible with Mark-10 indicators (sold separately) through unique Plug & Test® technology. Includes a certificate of calibration with data.

Specifications

Accuracy:	±0.1% of full scale + indicator or test frame
Safe Overload:	150% of full scale
Weight:	FS05-012 - FS05-100: 1.2 lb [0.5 kg] FS05-200 - FS05-500: 1.3 lb [0.6 kg]

Features



< Series FS05 sensor is shown mounted to the crosshead of an F305 test frame, configured for a tensile test.

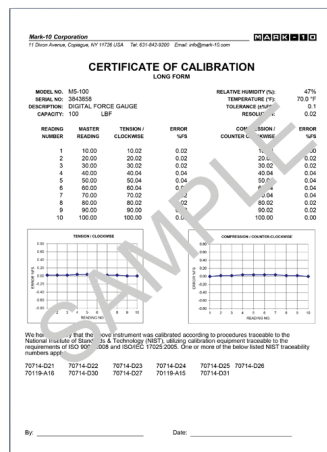

< Included certificate of calibration contains 10 data points in each measuring direction.

Dimensions in [mm]

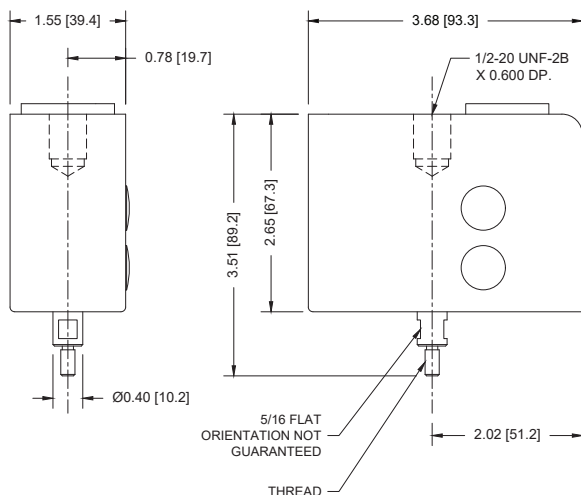

Model No.	Thread
FS05-012 - FS05-100	#10-32 UNF
FS05-200 - FS05-500	5/16-18 UNC

Optional Items



AC1083
Adapter, FS05 to Plug & Test® connector
 Adapts a Series FS05 load cell to Plug & Test® type interface, for use with a Mark-10 indicator. Also allows for mounting to Models F755(S) and F1505(S). Shown above with Model M51 indicator.



AC1084
Plug & Test® Extension cable
 24 in. / 610 mm extension facilitates easier connection to a Model M51 or M71 indicator for calibration.

In The Box

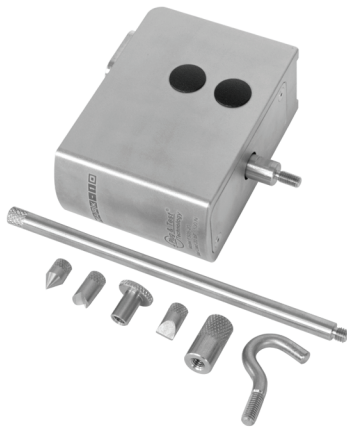

Series FS05 are shipped as shown at left, and include the following accessories:

- (1) Extension rod *
- (1) Hook *
- (1) Cone *
- (1) Chisel *
- (1) V-Groove *
- (1) Flat *
- (1) Coupling *
- (1) Certificate of calibration with data

* The specific accessory depends on the model. Refer to the website for details.

Capacity x Resolution

Model No.	lbF	ozF	gF	kgF	N	kN	mN
FS05-012	0.12 x 0.00005	2 x 0.001	50 x 0.02	-	0.5 x 0.0002	-	500 x 0.2
FS05-025	0.25 x 0.0001	4 x 0.002	100 x 0.05	-	1 x 0.0005	-	1000 x 0.5
FS05-05	0.5 x 0.0002	8 x 0.005	250 x 0.1	-	2.5 x 0.001	-	2500 x 1
FS05-2	2 x 0.001	32 x 0.02	1000 x 0.5	1 x 0.0005	10 x 0.005	-	-
FS05-5	5 x 0.002	80 x 0.05	2500 x 1	2.5 x 0.001	25 x 0.01	-	-
FS05-10	10 x 0.005	160 x 0.1	5000 x 2	5 x 0.002	50 x 0.02	-	-
FS05-20	20 x 0.01	320 x 0.2	10000 x 5	10 x 0.005	100 x 0.05	-	-
FS05-50	50 x 0.02	800 x 0.5	25000 x 10	25 x 0.01	250 x 0.1	-	-
FS05-100	100 x 0.05	1600 x 1	50000 x 20	50 x 0.02	500 x 0.2	-	-
FS05-200	200 x 0.1	3200 x 2	-	100 x 0.05	1000 x 0.5	1 x 0.0005	-
FS05-300	300 x 0.1	4800 x 2	-	150 x 0.05	1500 x 0.5	1.5 x 0.0005	-
FS05-500	500 x 0.2	8000 x 5	-	250 x 0.1	2500 x 1	2.5 x 0.001	-